

TCP Accelerator for BGAN

User manual for Windows® XP

Version 1.0

26.06.06

www.inmarsat.com/bgan

Whilst the information has been prepared by Inmarsat in good faith, and all reasonable efforts have been made to ensure its accuracy, Inmarsat makes no warranty or representation as to the accuracy, completeness or fitness for purpose or use of the information. Inmarsat shall not be liable for any loss or damage of any kind, including indirect or consequential loss, arising from use of the information and all warranties and conditions, whether express or implied by statute, common law or otherwise, are hereby excluded to the extent permitted by English law. INMARSAT is a trademark of the International Mobile Satellite Organisation, Inmarsat LOGO is a trademark of Inmarsat (IP) Company Limited. Both trademarks are licensed to Inmarsat Global Limited. © Inmarsat Global Limited 2006. All rights reserved.



Contents

1.0.	Introduction	3
1.1.	Purpose of this manual	3
1.2.	Scope	3
1.3.	Who should read this manual	3
1.4.	Assumptions	3
1.5.	How to use this manual	3
1.6.	Acronyms and abbreviations	4
1.7.	Associated documents	4
2.0.	Introducing TCP Accelerator	5
2.1.	The TCP Accelerator suite	5
2.2.	About TCP	5
2.3.	About TCP Accelerator	5
2.4.	When to use TCP Accelerator	6
2.5.	Deployment options	6
3.0.	Installing and configuring TCP Accelerator	8
3.1.	Minimum system requirements	8
3.2.	How to obtain the latest version of TCP Accelerator	8
3.3.	Installing TCP Accelerator	8
3.4.	Un-installing TCP Accelerator	12
3.5.	Managing and monitoring TCP Accelerator	14
4.0.	Troubleshooting and Known Issues	16
4.1.	Compatibility issues with Netscreen VPN	16
4.2.	Compatibility issues with Packet QoS Packet Scheduler and VPN clients	16
4.3.	LAN Properties shows no components after installation of TCP Accelerator	16
4.4.	Windows Firewall gives warning messages on start up after installation of TCP Accelerator	16
4.5.	Compatibility issues with Windows XP Service Pack 2 Bluetooth driver	18
4.6.	TCP Accelerator stops spoofing if you install Windows XP Hotfix 886199 on your computer	18
4.7.	Devices are still shown after un-installation of TCP Accelerator	19
4.8.	Further support	19
5.0.	Optimising performance of end host servers through adjustment of TCP parameters	20
5.1.	Configuring TCP parameters manually	20



1.0. Introduction

1.1. Purpose of this manual

The purpose of this document is to provide guidance on the installation and configuration of the client version of TCP Accelerator for the BGAN terminal, using the Windows XP operating system.

NOTE: a Mac OSX version will be available in August 2006.

1.2. Scope

This document provides an overview of TCP Accelerator, and gives instructions on installing and configuring TCP Accelerator. It also provides troubleshooting information.

1.3. Who should read this manual

This document is intended for TCP Accelerator end users, developers and testing teams.

1.4. Assumptions

- You have access to all the programs referenced in this document.
- You have a good working knowledge of TCP/IP, and a familiarity with Windows XP.

1.5. How to use this manual

This section explains how the information in this manual is organized, and introduces the conventions that have been used.

Introducing the chapters

The following table gives an overview of the chapters in this manual:

Chapter	Contents
Introduction	Introduces TCP Accelerator, defines the purpose, scope, and intended audience of this manual, explains how information is organized in this document.
Introducing TCP Accelerator	Provides a brief overview of TCP Accelerator.
Installing TCP Accelerator	Details the requirements for use of TCP Accelerator, and provides detailed installation instructions.
Configuring and monitoring TCP Accelerator	Explains how to configure TCP Accelerator, and monitor status and alarms.
Troubleshooting and known issues	Provides some hints and tips, and details known issues.



Text conventions

This manual uses typographical conventions to help you easily identify certain types of information. The following table introduces the conventions used:

Convention	Usage	Example
"Exclamation points"	References to sections, chapters or other documents	See "Introduction"
Courier font	System-generated messages	Choose another folder
Bold Courier font	Commands that you must enter	Run CMD
Bold text	Options that you select on a user interface	Click on Next

1.6. Acronyms and abbreviations

Acronym	Explanation
TCP	Transmission Control Protocol
TCP/IP	Transmission Control Protocol/Internet Protocol
UT	User terminal
SOHO	Small office home office
NDIS	Network Driver Interface Specification

1.7. Associated documents

- BGAN LaunchPad Help.



2.0. Introducing TCP Accelerator

The client version of TCP Accelerator is an application that can be installed on a BGAN user's computer to significantly enhance performance when sending TCP traffic over BGAN. The client version of TCP Accelerator is available for download free of charge.

This chapter gives a brief overview of TCP Accelerator, and how it operates on the BGAN terminal and connected devices.

2.1. The TCP Accelerator suite

The following components are required to accelerate TCP traffic in both directions.

- TCP Accelerator Client: this is a client based software application and is installed on the user's PC to enhance performance in the send/upload direction.
- TCP Accelerator Network: a server based application for non-VPN users. This sits within the network and together with TCP Accelerator Client enhances performance in the receive/download direction. (To be released.)
- TCP Accelerator VPN Enterprise: a server based application for VPN users. This sits within the Enterprise site and together with TCP Accelerator Client enhances performance in the receive/download direction. (To be released.)

At the time of publication, only TCP Accelerator Client is available, and so only performance in the send direction can be improved by the software. However, the performance can be further enhanced by modifying the server configuration. Please see section 5.0 "Optimising performance of end host servers through adjustment of TCP parameters"

2.2. About TCP

Transmission Control Protocol (TCP) enables two hosts, usually computers to establish a connection and exchange data reliably. It improves the efficiency of data transfer by dividing the data into packets, then delivering the packets in the same order that they were sent.

2.3. About TCP Accelerator

The TCP Accelerator enhances the performance of TCP over a satellite network such as the BGAN network by providing:

- Fast start - useful for transferring small amounts of data, since traditional TCP is often slow with smaller data transfers.
- Increased window size - improves TCP performance in larger bandwidth applications
- Delay based congestion control - ensures high transfer rates and less delay.

TCP Accelerator splits an end-to-end TCP connection into two, to enhance the performance of TCP on your BGAN terminal. One of the two TCP connections is a high-delay, wireless/satellite packet data link, and the other is a terrestrial link. TCP Accelerator operates each link separately, using built-in algorithms to optimize the operation of the link for the physical media being used. As the links can be of different types and different bandwidths, TCP Accelerator can buffer intermediate packets and control the flow on both links. TCP Accelerator operates in a way that is transparent to the end-to-end connection.

TCP Accelerator is installed on a device connected to the terminal, for example a computer running Windows XP. The terminal contains the radio and related software and hardware. The computer



operates the TCP accelerator software. The diagram below shows how the terminal integrates TCP Accelerator.

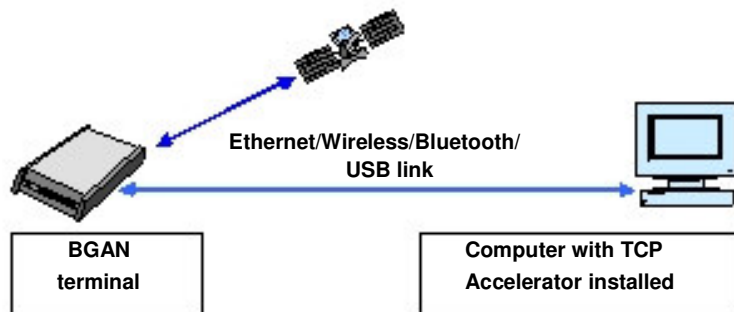

2.4. When to use TCP Accelerator

TCP Accelerator has been tested and found compatible with the following BGAN terminals:

- Nera WorldPro 1000
- Thrane & Thrane EXPLORER 500
- HNS 9201

At the time of publication, TCP Accelerator has not been tested with the Thrane & Thrane EXPLORER 700, Thrane & Thrane EXPLORER 300 or Nera WorldPro 1010. However, the software should be compatible with these terminals.

The TCP accelerator will enhance the performance of BGAN when your PC is sending data from TCP applications ONLY. Typical TCP applications include:

- File transfer
- Email
- Web browsing
- Webmail
- VPN with Checkpoint, Nortel, Cisco and Netscreen. Other VPN applications may work but they have not been tested by Inmarsat.

When the client version of TCP Accelerator is enabled, the absolute improvement seen depends on network usage, file size and terminal type. User tests * have shown significant improvements in upload speed with DOS FTP.

As an example, TCP office applications such as email and FTP have typical file sizes of less than 2MB. For these file sizes and traffic types, the client version of BGAN TCP Accelerator is particularly effective, delivering improvements in average throughput rates of over 100%.

The Accelerator will NOT enhance performance when you are using any streaming based application including video streaming and audio streaming because these are UDP based applications.

* Note that test results have been accurately assessed and reported using an ethereal trace capture process. Typical measurement software applications generally over-report performance.

2.5. Deployment options

TCP Accelerator can be deployed in three different configurations, as shown in the following diagram. The basic functionality of TCP Accelerator is the same in all configurations, although the capabilities of the terminal may change depending on the deployment option you use.

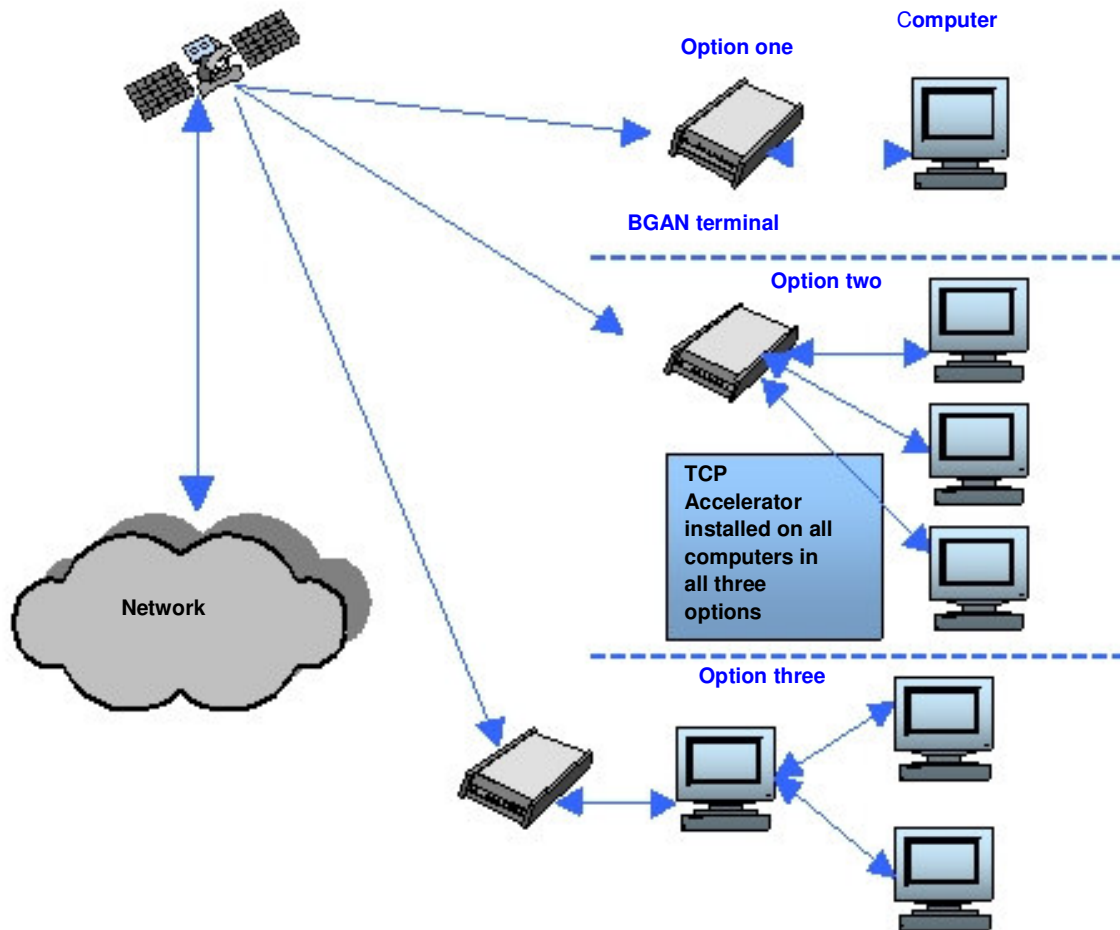

The three deployment options are:

- **Single computer connected to single terminal.** In this configuration, the computer is connected to a single terminal. This is the most widely used configuration. The applications using TCP accelerator are installed on the computer.
- **Multiple computers connected to single terminal.** In this configuration, more than one computer is connected to a single terminal. The applications using TCP accelerator are installed on each of the computers.
- **Single computer connected to other computer.** This configuration is used in some SOHO environments. In this configuration, TCP Accelerator has to cater to more connections and load as compared to the other two options. The applications using TCP Accelerator may be installed external to the computers, therefore the terrestrial link can also be external to the computer. It is being proposed that the TCP Accelerator enterprise solution be used in this configuration, as it meets the necessary requirements of the solution. However, this is the least preferred configuration and is only used for SOHO environments with 2-4 users.



3.0. Installing and configuring TCP Accelerator

Inmarsat recommends that you install and enable the client version of BGAN TCP Accelerator as it enhances performance when sending files. This chapter describes the installation procedures for the client version of TCP Accelerator.

3.1. Minimum system requirements

The following are the mandatory hardware and software requirements for successful installation of TCP Accelerator on your computer:

Hardware requirements

- Intel Pentium IV, or equivalent.
- 256 MB RAM.
- 20 MB hard disc space.

Software requirements

- Windows XP SP2 installed on your computer.
NOTE: Windows XP 64bit is not supported.

3.2. How to obtain the latest version of TCP Accelerator

If you purchased a BGAN terminal after June 2006, a CD containing the TCP Accelerator should be available on a CD in the box with the terminal. Refer to section 3.3 "Installing TCP Accelerator" for details on the installation process.

You can also check for and download the latest version of the TCP Accelerator either:

- Using the BGAN LaunchPad update process. In BGAN LaunchPad, select the menu item **Updates > Check for updates**, and check for TCP Accelerator updates. Now follow the on screen instructions to install the software automatically.
- By browsing to **www.inmarsat.com/bgan-updates**, and downloading the latest TCP Accelerator release to your computer. Refer to section 3.3 "Installing TCP Accelerator" for details on the installation process.

Note that you do not have to download software over BGAN; you can use any other reliable broadband network. Inmarsat suggests that you do not download software using a BGAN terminal unless absolutely necessary, as you will be charged for the download and the files may be large.

3.3. Installing TCP Accelerator

Use this section if you are installing TCP Accelerator from a CD-ROM, or if you have downloaded the application from the Inmarsat web site to your computer. These instructions are not needed if you use the BGAN LaunchPad update process.

You must have administrator privileges to install TCP Accelerator on a Windows XP computer. TCP Accelerator is an NDIS intermediate driver, which is loaded into the Windows XP kernel.

To install the driver, do the following:

1. Either:
 - Insert the Setup Wizard CD-ROM into the computer's CD-ROM drive, or
 - Double-click on the **Setup.exe** file you downloaded to your computer.

The Setup Wizard launches automatically, and the following screen is displayed:

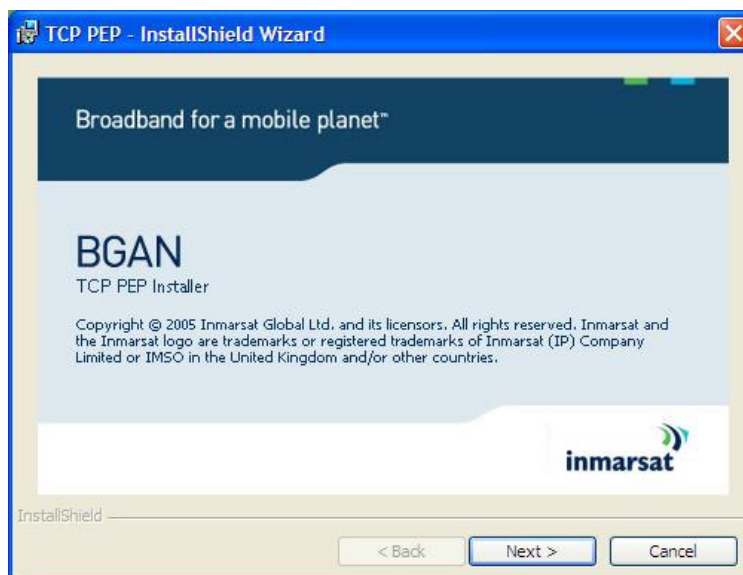

2. Click on **Next**. The Terms and Conditions screen is displayed, as shown below:

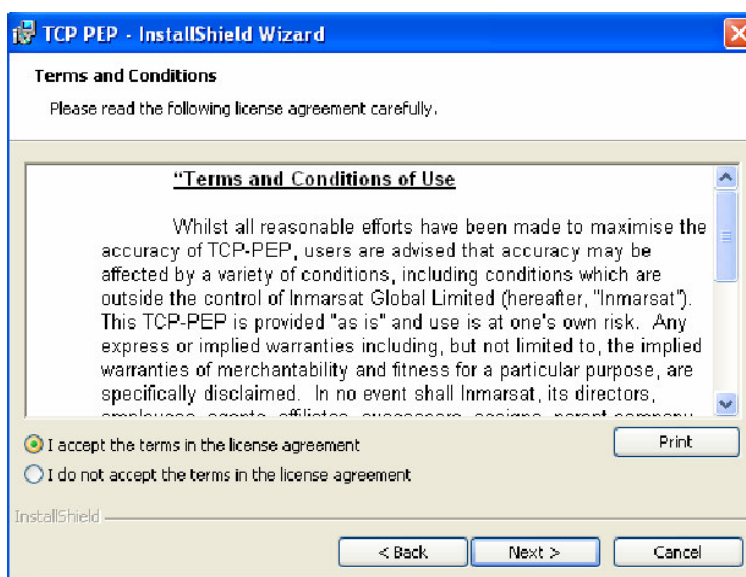



3. Select the **I accept the terms in the license agreement** radio button, and click **Next**. The Destination Folder screen is displayed, as shown below:

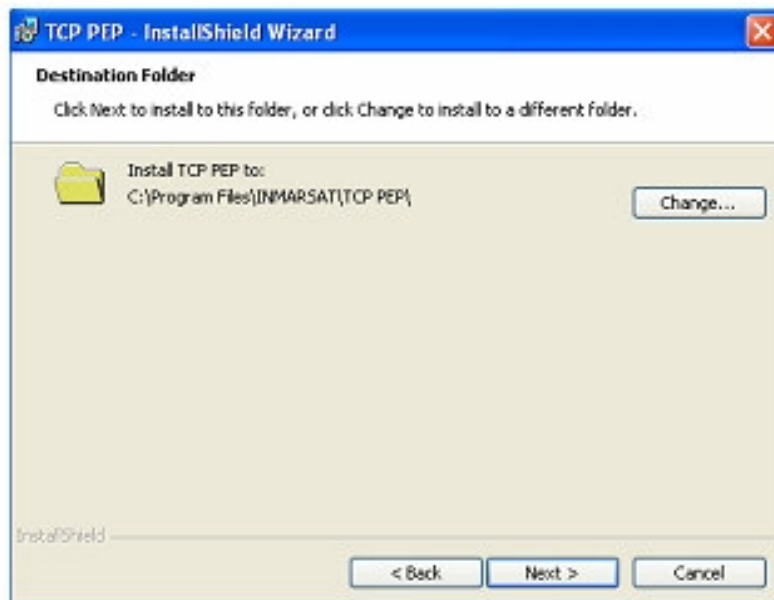

4. If you want the program files to be installed in the default directory, click on **Next**. To select a different directory, click on **Change...**, and select the required directory, then click on **Next**. The Preparing to Install screen is displayed, as shown below, and TCP Accelerator performs pre-installation checks:

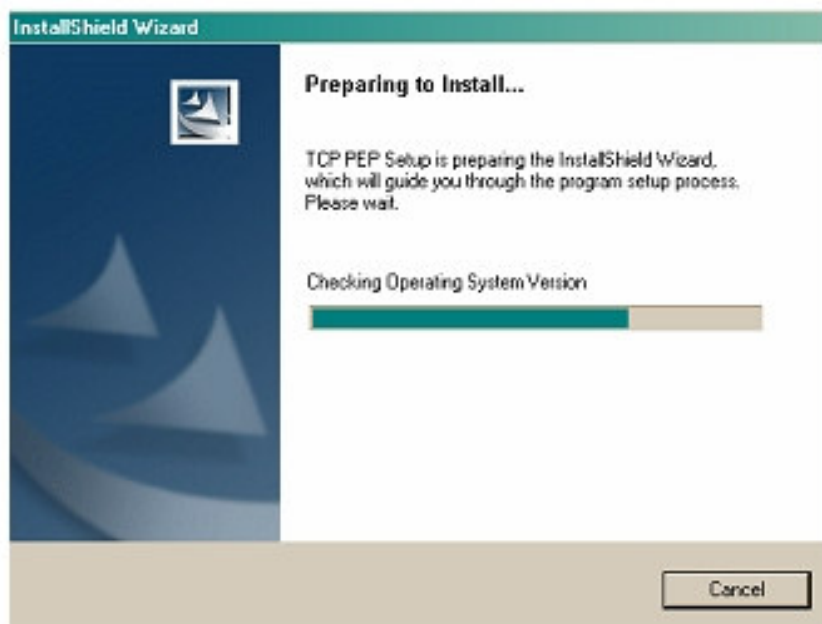

- If the program detects that your computer is not fully optimized for TCP Accelerator, the following screen is displayed:

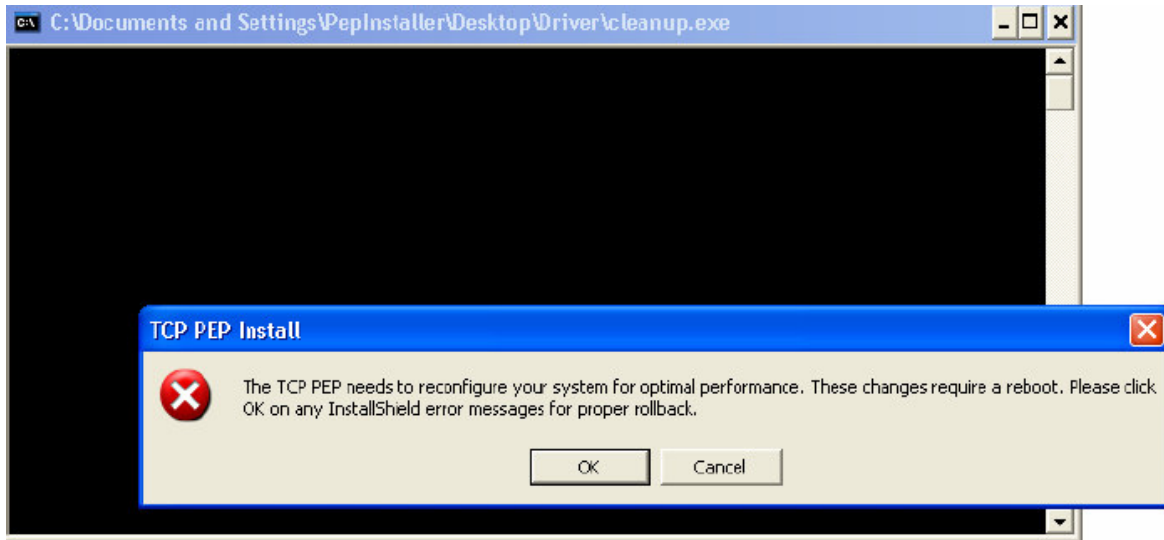

If you see this screen, click on **OK** when prompted to reboot your computer. This is a one time optimization, and is not repeated for subsequent TCP Accelerator releases.

- If the program fails Windows Logo testing, the following screen is displayed:

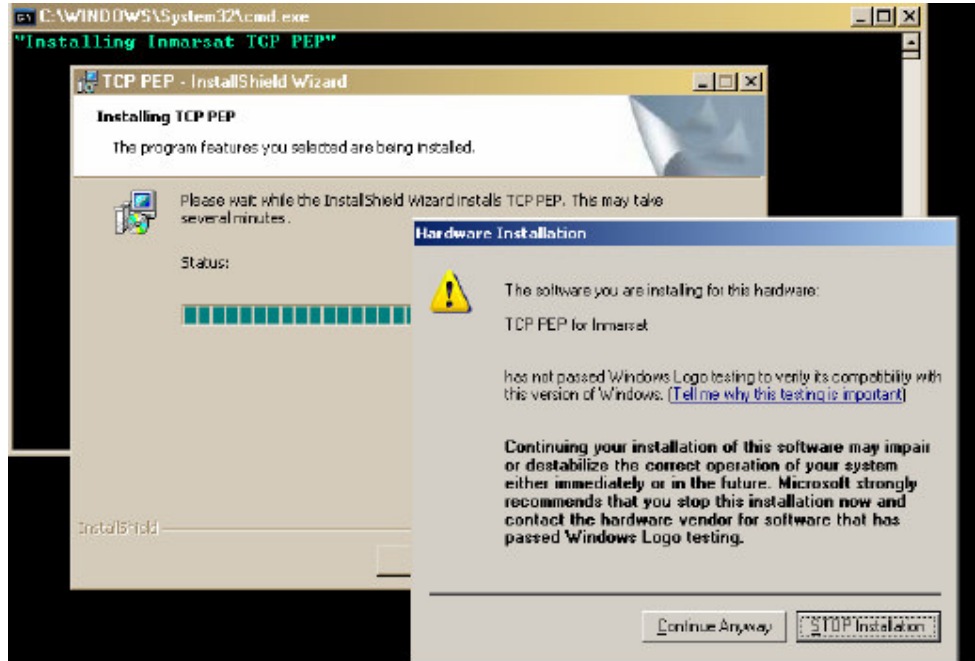

If you see this screen, click on **Continue Anyway**. Note that you may see this screen more than once: click on **Continue Anyway** each time. (This screen displays if the driver is yet to formally complete the certification procedure for Windows.)

When the installation is complete, the following screen is displayed:



5. Click on **Finish** to complete the installation. The following screen is displayed:

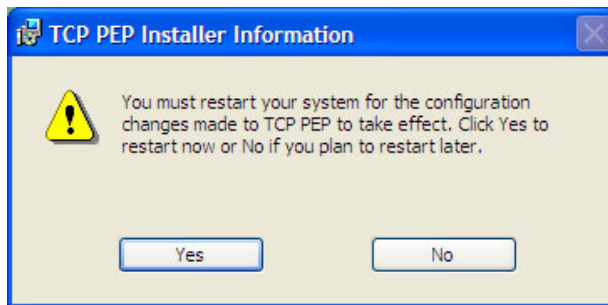

6. Click on **Yes** to restart the computer.

You must now enable TCP Accelerator using BGAN LaunchPad, as described in section 3.5 "Managing and monitoring TCP Accelerator".

3.4. Un-installing TCP Accelerator

NOTE: Inmarsat recommends that you save your work and close all applications before proceeding. Any driver de-installation poses the risk of crashing your operating system.

NOTE: Driver de-installation usually requires administrator privileges. Inmarsat recommends that you log in to an account with administrator privileges before proceeding.



To un-install TCP Accelerator, do the following in Windows XP:

1. Click on **Start**, then **Control Panel**, then **Add or Remove Programs** to display the Add or Remove Programs screen, as shown below:

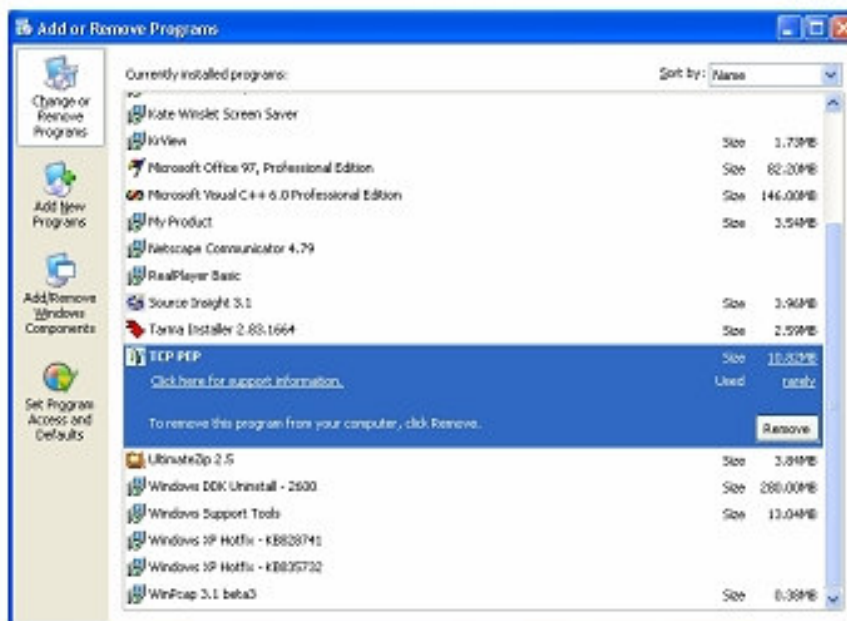

2. Select **TCP Accelerator**, then click on **Remove**. You are prompted to confirm the deletion; click on **Yes**. The following screen displays:

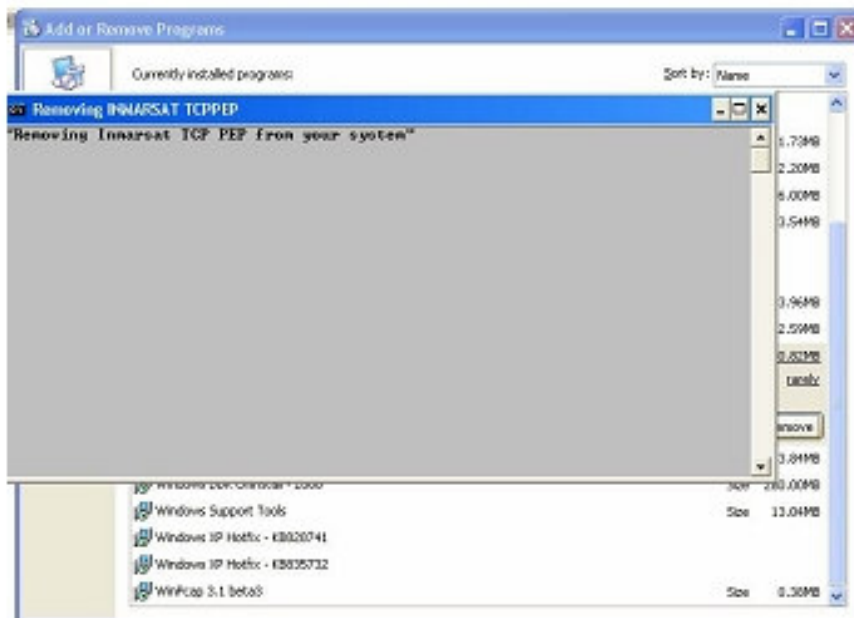



When TCP Accelerator is removed from your computer, you are prompted to reboot the computer, as shown below:

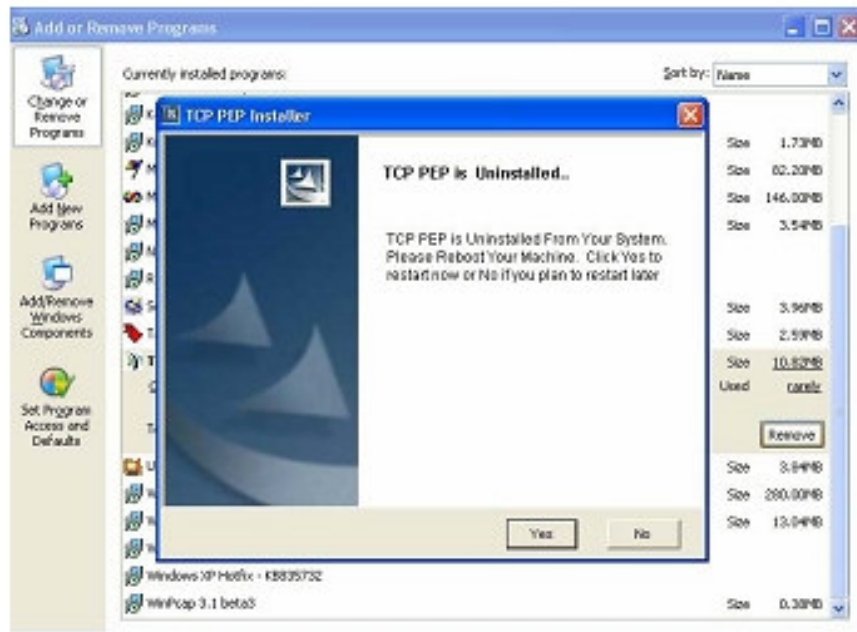

Click on **Yes** to reboot the computer.

3.5. Managing and monitoring TCP Accelerator

You must use BGAN LaunchPad to start TCP Accelerator.

You can manage and monitor the operation of TCP Accelerator using BGAN LaunchPad. You can enable and disable TCP Accelerator and monitor any errors by opening the TCP Accelerator dialog in BGAN LaunchPad.

Operation following initial installation of the Accelerator

After initial installation of the TCP Accelerator, its status will be off. To experience the benefits of the accelerator you must switch it on. The accelerator can only be switched on after the terminal is registered with the network. After you have registered, select **BGAN Services > TCP Accelerator**. The following screen is displayed:





Select **ON** from the drop down list to enable TCP Accelerator and click **Apply**.

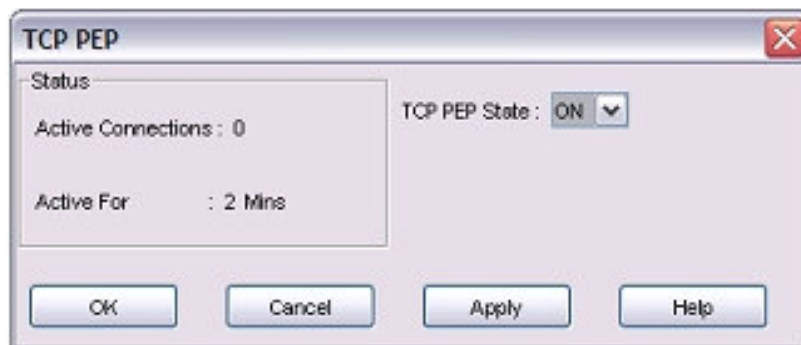

The following screen is displayed if the settings have been successfully changed.

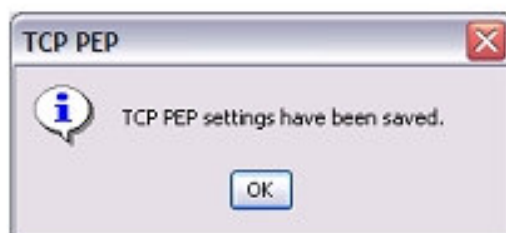

BGAN LaunchPad automatic control

BGAN LaunchPad remembers the ON/OFF status of the TCP Accelerator from session to session. When BGAN LaunchPad starts up it checks the status of TCP Accelerator when last used with BGAN LaunchPad. If it was on, BGAN LaunchPad switches the accelerator on, if it was off, no action is taken.

When BGAN LaunchPad exits, it switches the TCP accelerator off.

Inmarsat recommends that you switch BGAN TCP Accelerator ON if you commonly use TCP applications for sending data.



4.0. Troubleshooting and Known Issues

This section helps you with possible problems and issues you might encounter during the installation and use of TCP Accelerator.

4.1. Compatibility issues with Netscreen VPN

Netscreen VPN client has compatibility issues with other NDIS intermediate drivers like TCP Accelerator. Therefore, you must un-install Netscreen VPN client must before installing TCP Accelerator. (The TCP Accelerator install program detects the presence of Netscreen VPN client and prompts you to un-install it.) Once TCP Accelerator is installed, you can re-install Netscreen VPN.

4.2. Compatibility issues with Packet QoS Packet Scheduler and VPN clients

VPN clients have compatibility issues when installed with Microsoft QoS packet scheduler and TCP Accelerator. Therefore, the TCP Accelerator install program un-installs the QoS packet scheduler prior to installation of TCP Accelerator. This incompatibility with QoS Packet Scheduler is recorded in many VPN advisories and release notes available on the Internet.

4.3. LAN Properties shows no components after installation of TCP Accelerator

This occurs when TCP Accelerator is not properly installed, and appears as a bug in the **Local Area Connection Properties** window. If you select **TCP Accelerator for Inmarsat** and click on **OK**, an error message is displayed indicating that no components are installed. If you click on **Cancel** to close the Local Area Connection Properties dialog box, and then re-open it again, the list of components displays.

To remove TCP Accelerator, select **TCP Accelerator For Inmarsat**, click on **Uninstall** and confirm the un-installation. Before you make another installation attempt, make sure that **Windows** is NOT set to block the installation of unsigned drivers, as follows:

1. Right-click on **My Computer**, then select **Properties**.
2. Select the **Hardware** tab, and click on **Driver Signing...**
3. Make sure that the **Block - Never install unsigned driver software** radio button is not selected. If it is, select one of the other radio buttons, and click on **OK**.

4.4. Windows Firewall gives warning messages on start up after installation of TCP Accelerator

When you install TCP Accelerator on a Windows XP Service Pack 2 computer with firewall activated, the following messages are displayed when you start the computer. To prevent these messages from displaying on future start up, click on **Unblock** in each of the following screens.





4.5. Compatibility issues with Windows XP Service Pack 2 Bluetooth driver

Windows XP Service Pack 2 includes a generic Bluetooth driver. When you plug in a Bluetooth device, Windows installs this generic Bluetooth driver. If you then try to install a manufacturer-specific Bluetooth driver on Windows XP Service Pack 2, this driver does not work, because Windows XP continues to use the generic driver.

TCP Accelerator does not bind with the Microsoft generic driver. Therefore, to make TCP Accelerator work on Bluetooth devices, you must force Windows XP to use the manufacturer-specific Bluetooth driver.

To do this, do the following before you plug in the device (these notes make reference to Belkin Bluetooth device):

1. If you have any Bluetooth software apart from the included Windows drivers installed, uninstall the software and reboot.
2. Install the Belkin Bluetooth software. When prompted to plug in the Bluetooth device, do NOT plug in the device. Click **Cancel**.
3. When the Belkin setup has completed, plug in your Bluetooth device and let Windows install its own driver. (There should be two Bluetooth icons in the system tray; one blue-white, which is the Windows driver, and one blue-red, which is the Belkin driver that is deactivated.)
4. Select **Device Manager**, right click on **Generic Bluetooth Radio** and select **Update Driver**. Prevent Windows XP from connecting to the Internet, then select **Choose software from a list or specified location**, and in the next window, select **Don't search, but select the driver to install**.
5. In the next window, activate **Show compatible hardware** (if it isn't activated already) and select your manufacturer's driver instead of the **Generic Bluetooth Radio** driver.
6. Click **Next** until the new driver is installed. Now the Belkin system tray icon should be blue-white as well, activated and ready to use.
7. If you now double click on **My Bluetooth Places**, the Belkin software installation is continued and finished.

The above steps force Windows XP to use the Bluetooth software provided by the manufacturer. TCP Accelerator can now bind to this driver, and the Bluetooth device is ready to use with TCP Accelerator.

4.6. TCP Accelerator stops spoofing if you install Windows XP Hotfix 886199 on your computer

TCP Accelerator goes into admission control and stops spoofing the packets if you install Windows XP Hotfix 886199 on your computer. The details of this Hotfix are given at the following URL:

<http://support.microsoft.com/default.aspx?scid=kb;en-us;886199>

Microsoft recommends that the fix is still under test and should only be installed if it is urgently required and you have experienced the problem fixed by this Hotfix. The fix interferes with the operation of TCP Accelerator.



4.7. Devices are still shown after un-installation of TCP Accelerator

When you un-bind TCP Accelerator from an adapter or even completely un-install the program, the devices it created still display in **Hardware Device Manager** and are not deleted until you reboot. If you re-bind to an adapter or re-install the protocol without rebooting, you will see two entries per adapter, one having a number in brackets after the name. This is a bug in Windows. While the additional entries do not affect operations, they can be confusing. They can be deleted by a reboot. **Background:** This issue is known to Microsoft and currently intended behavior. Microsoft is working on a fix.

4.8. Further support

For further support with TCP Accelerator, visit the Inmarsat Web site at www.inmarsat.com and click on Customer Support.



5.0. Optimising performance of end host servers through adjustment of TCP parameters

It is possible to improve the performance of BGAN on the server that is receiving the data by setting the following TCP parameters on the server.. Follow the instructions below to implement the change:

Disclaimer

Modifying the registry may cause serious problems that may require you to reinstall your operating system. We cannot guarantee that problems resulting from modifications to the registry can be solved. Use the information provided at your own risk.

5.1. Configuring TCP parameters manually

Using Windows Registry Editor, enter the following settings when configuring the TCP parameters. Please ensure you reboot after the settings have been entered.

Registry Settings

System Key: [HKEY_LOCAL_MACHINE\SYSTEM\CurrentControlSet\Services\Tcpip\Parameters]

Value Name: TcpWindowSize
Data Type: REG_DWORD (DWORD Value)
Value: HEX: 1FFFF or Decimal: 131071

Value Name: Tcp1323Opts
Data Type: REG_DWORD (DWORD Value)
Value: HEX: 1 or Decimal: 1